



WIGGIN MEANS PRECAST CO., INC.

P.O. BOX 1507 POCASSET, MASSACHUSETTS 02559

TEL: 508.564.6776 FAX: 508.564.6770

www.wigginprecast.com

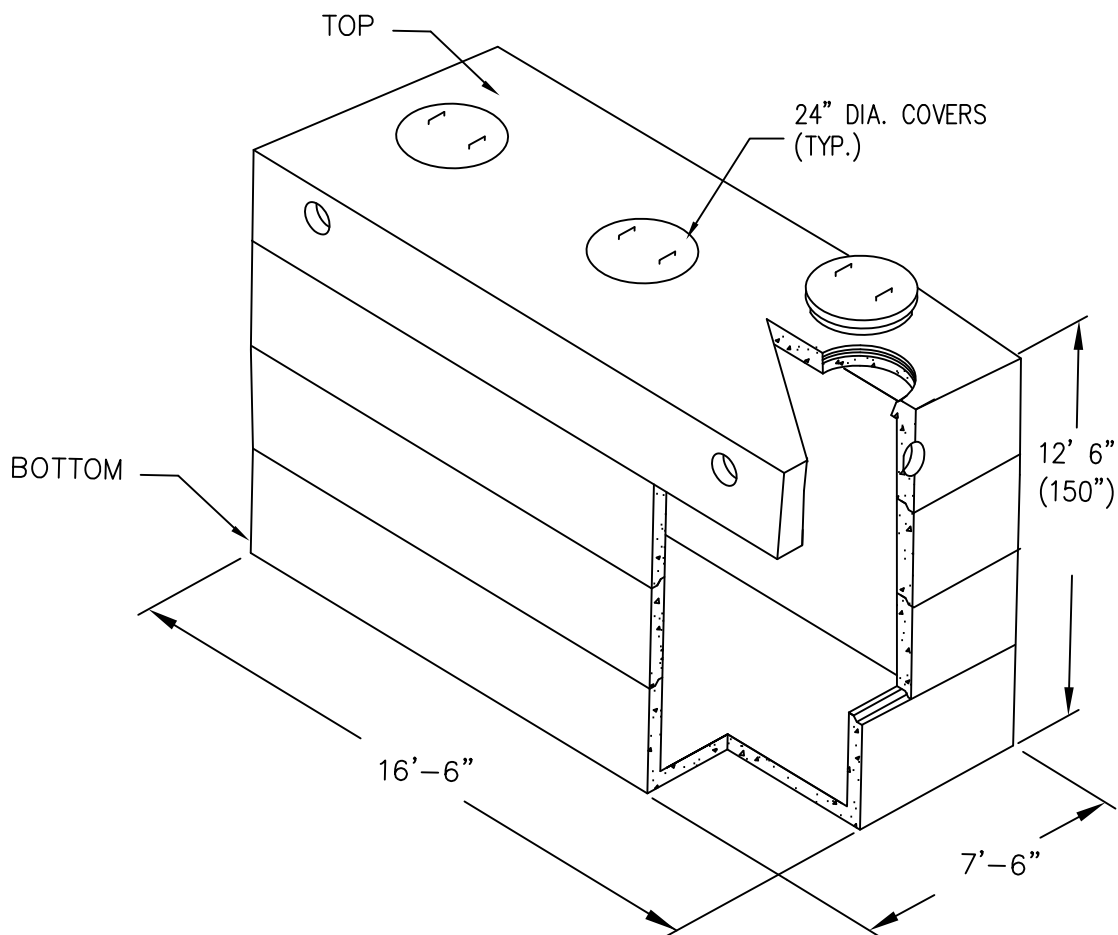

**8,000 GALLON
PRECAST SEPTIC TANK/H₂O
AVAILABLE IN 2 OR 3 COMPARTMENT**

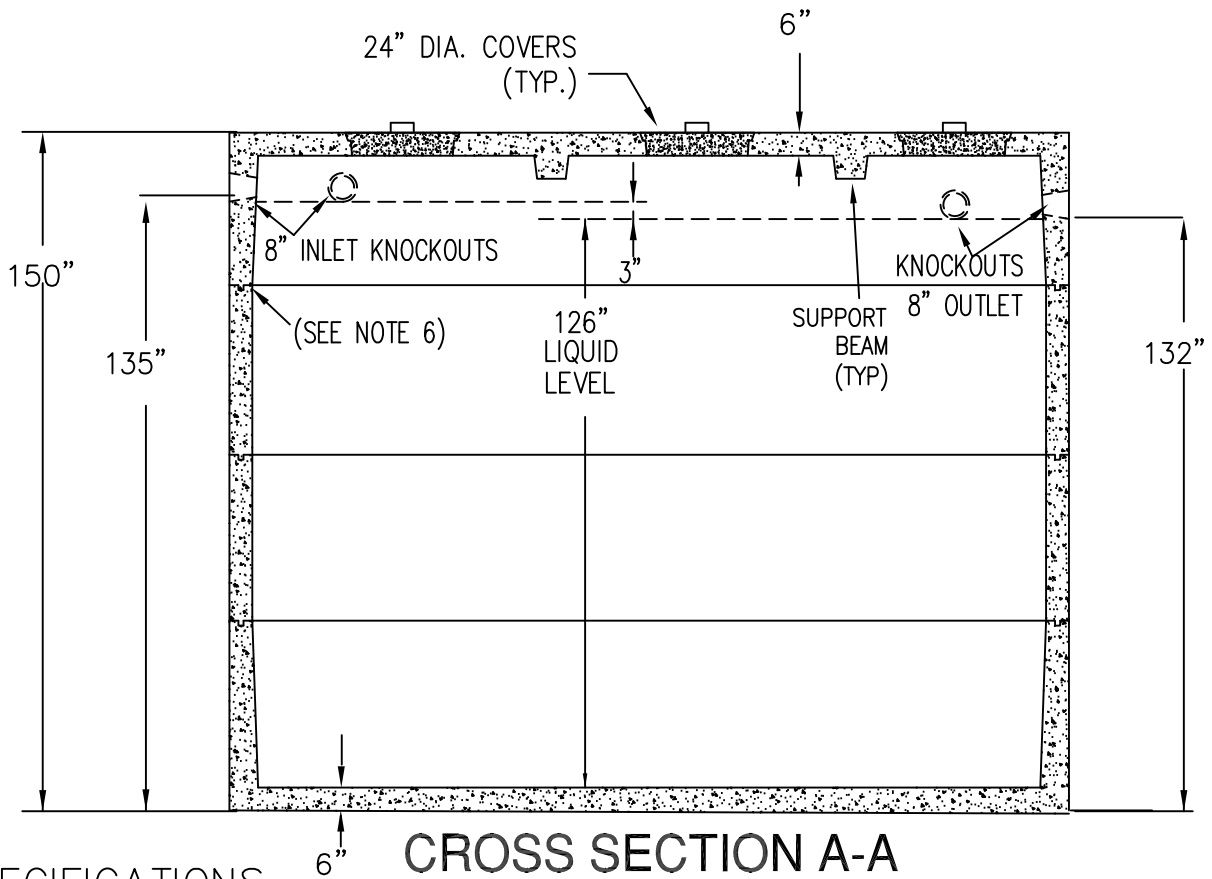
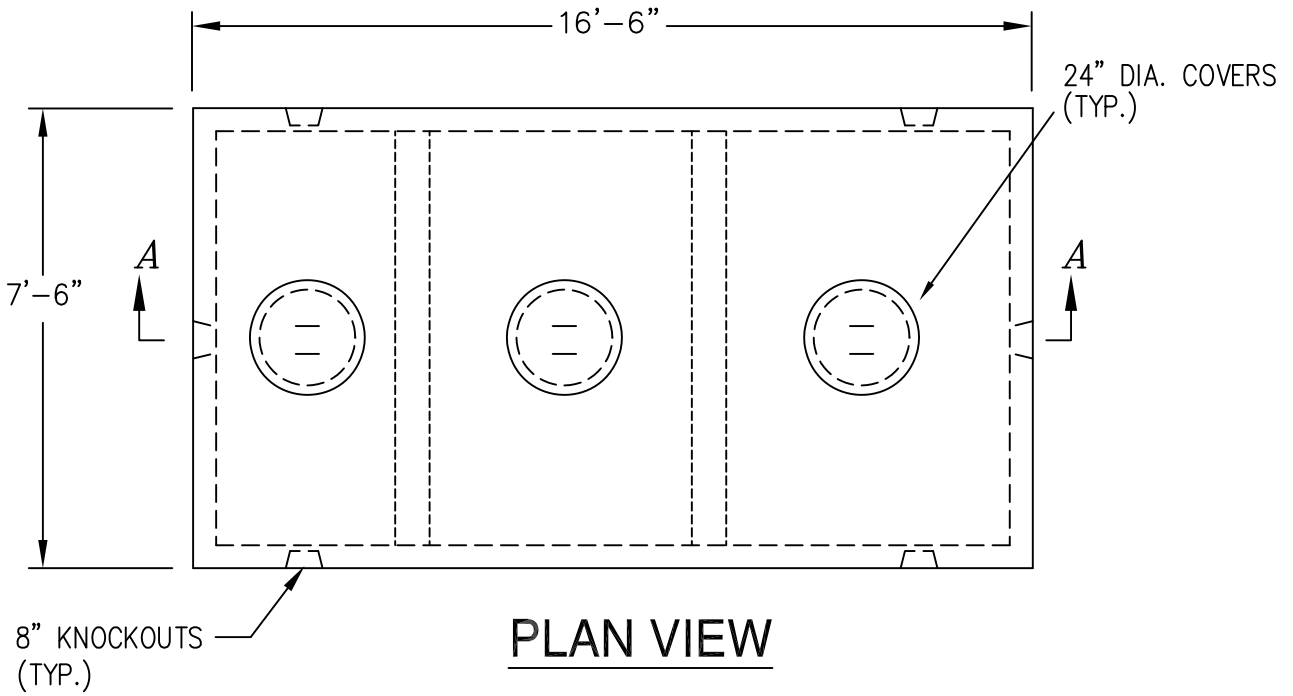

SPECIFICATIONS

- 1.) CONCRETE STRENGTH F'C 5,000 PSI @ 28 DAYS. DENSITY 150 PCF.
- 2.) CEMENT, PORTLAND TYPE I OR III. ASTM C150-81.
- 3.) ADMIXTURES, AIR & PLASTICIZERS @ ASTM C233-82.
- 4.) REINFORCING ASTM A615 FOR WIRE FABRIC, GRADE 60 BAR.
- 5.) DESIGN LOADING AASHTO HS20-44. - WEIGHT 52,054 LBS
- 6.) CONSTRUCTION JOINTS SEALED WITH BUTYL RUBBER.